

Micropower Voltage Detector

Features

- Ultra-low supply current: 1.75 μA (max.)
- Precision monitoring options of:
 - 1.90V, 2.32V, 2.63V, 2.90V, 2.93V, 3.08V, 4.38V and 4.63V
- Resets microcontroller in a power-loss event
- Active-low V_{OUT} pin:
 - **MCP111** active-low, open-drain
 - **MCP112** active-low, push-pull
- Available in SOT23-3, TO-92 and SC70 packages
- Temperature Range:
 - Extended: -40°C to $+125^{\circ}\text{C}$
(except MCP1XX-195)
 - Industrial: -40°C to $+85^{\circ}\text{C}$ (**MCP1XX-195 only**)

Applications

- Critical μC and μP Power-monitoring Applications
- Computers
- Intelligent Instruments
- Portable Battery-Powered Equipment

Block Diagram

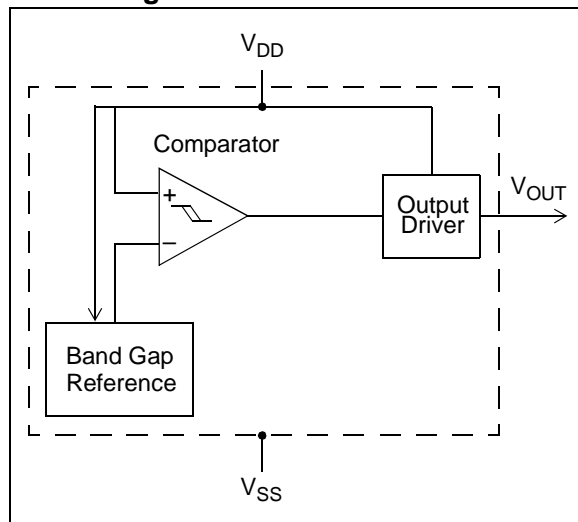

Description

The MCP111/112 are voltage-detecting devices designed to keep a microcontroller in reset until the system voltage has reached, and stabilized, at the appropriate level for reliable system operation. These devices also operate as protection from brown-out conditions when the system supply voltage drops below a safe operating level. The MCP111 and MCP112 are available in eight different trip voltages.

The MCP111 has an open-drain output with an active-low pin (V_{OUT}). This device will assert V_{OUT} when the voltage on the V_{DD} pin is below the trip-point voltage.

The MCP112 has a push-pull output and will assert an active-low signal (V_{OUT} pin) when the voltage on the V_{DD} pin is below the trip-point voltage.

During operation, the output (V_{OUT}) remains at a logic-high as long as V_{DD} is greater than the specified threshold voltage. When V_{DD} falls below the voltage trip point, V_{OUT} is driven low.

Package Types

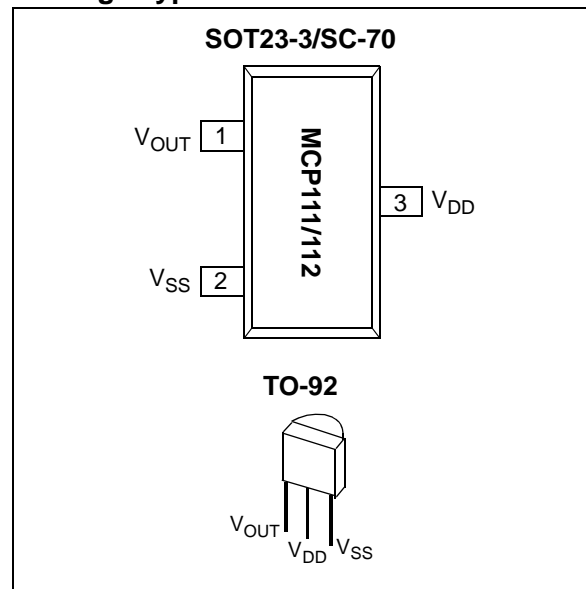

MCP111/112

1.0 ELECTRICAL CHARACTERISTICS

Absolute Maximum Ratings†

| | |
|---|------------------------------|
| V_{DD} | 7.0V |
| Input current (V_{DD}) | 10 mA |
| Output current (\overline{RST}) | 10 mA |
| Rated Rise Time of V_{DD} | 100V/ μ s |
| All inputs and outputs w.r.t. V_{SS} | -0.6V to ($V_{DD} + 1.0$ V) |
| Storage temperature | -65°C to +150°C |
| Ambient temp. with power applied | -40°C to +125°C |
| Maximum Junction temp. with power applied | 150°C |
| ESD protection on all pins | ≥ 2 kV |

† **Notice:** Stresses above those listed under “Maximum Ratings” may cause permanent damage to the device. This is a stress rating only and functional operation of the device at those or any other conditions above those indicated in the operational listings of this specification is not implied. Exposure to maximum rating conditions for extended periods may affect device reliability.

DC CHARACTERISTICS

| Electrical Specifications: Unless otherwise indicated, all limits are specified for $V_{DD} = 1$ V to 5.5V, $R_{PU} = 100$ k Ω (only MCP111), $T_A = -40^\circ\text{C}$ to $+125^\circ\text{C}$. | | | | | | | |
|---|--|------------|-----------|-------|-----------------------|--|--|
| Parameters | Sym | Min | Typ | Max | Units | Conditions | |
| Operating Voltage Range | V_{DD} | 1.0 | — | 5.5 | V | | |
| Specified V_{DD} Value to V_{OUT} low | V_{DD} | 1.0 | — | | V | $I_{\overline{RST}} = 10 \mu\text{A}$, $V_{\overline{RST}} < 0.2$ V | |
| Operating Current | I_{DD} | — | < 1 | 1.75 | μA | | |
| V_{DD} Trip Point | MCP1XX-195 MCP1XX-240 MCP1XX-270 MCP1XX-290 MCP1XX-300 MCP1XX-315 MCP1XX-450 MCP1XX-475 | V_{TRIP} | 1.872 | 1.900 | 1.929 | V | $T_A = +25^\circ\text{C}$ (Note 1) |
| | | | 1.853 | 1.900 | 1.948 | V | $T_A = -40^\circ\text{C}$ to $+85^\circ\text{C}$ (Note 2) |
| | | | 2.285 | 2.320 | 2.355 | V | $T_A = +25^\circ\text{C}$ (Note 1) |
| | | | 2.262 | 2.320 | 2.378 | V | Note 2 |
| | | | 2.591 | 2.630 | 2.670 | V | $T_A = +25^\circ\text{C}$ (Note 1) |
| | | | 2.564 | 2.630 | 2.696 | V | Note 2 |
| | | | 2.857 | 2.900 | 2.944 | V | $T_A = +25^\circ\text{C}$ (Note 1) |
| | | | 2.828 | 2.900 | 2.973 | V | Note 2 |
| | | | 2.886 | 2.930 | 2.974 | V | $T_A = +25^\circ\text{C}$ (Note 1) |
| | | | 2.857 | 2.930 | 3.003 | V | Note 2 |
| | | | 3.034 | 3.080 | 3.126 | V | $T_A = +25^\circ\text{C}$ (Note 1) |
| | | | 3.003 | 3.080 | 3.157 | V | Note 2 |
| V_{DD} Trip Point Tempco | T_{TPCO} | — | ± 100 | — | ppm/ $^\circ\text{C}$ | | |
| | | | | | | | |
| Threshold Hysteresis (min. = 1%, max = 6%) | MCP1XX-195 MCP1XX-240 MCP1XX-270 MCP1XX-290 MCP1XX-300 MCP1XX-315 MCP1XX-450 MCP1XX-475 | V_{HYS} | 0.019 | — | 0.114 | V | $T_A = +25^\circ\text{C}$ |
| | | | 0.023 | — | 0.139 | V | |
| | | | 0.026 | — | 0.158 | V | |
| | | | 0.029 | — | 0.174 | V | |
| | | | 0.029 | — | 0.176 | V | |
| | | | 0.031 | — | 0.185 | V | |
| | | | 0.044 | — | 0.263 | V | |
| | | | 0.046 | — | 0.278 | V | |

Note 1: Trip point is $\pm 1.5\%$ from typical value.

Note 2: Trip point is $\pm 2.5\%$ from typical value.

DC CHARACTERISTICS (CONTINUED)

Electrical Specifications: Unless otherwise indicated, all limits are specified for $V_{DD} = 1V$ to $5.5V$, $R_{PU} = 100\text{ k}\Omega$ (only **MCP111**), $T_A = -40^\circ\text{C}$ to $+125^\circ\text{C}$.

| Parameters | Sym | Min | Typ | Max | Units | Conditions |
|---|----------|----------------|-----|-----|---------------|---|
| V_{OUT} Low-level Output Voltage | V_{OL} | — | — | 0.4 | V | $I_{OL} = 500\ \mu\text{A}$, $V_{DD} = V_{TRIP(MIN)}$ |
| V_{OUT} High-level Output Voltage | V_{OH} | $V_{DD} - 0.6$ | — | — | V | $I_{OH} = 1\ \text{mA}$, For only MCP112 (push-pull output) |
| Open-Drain Output Leakage Current (MCP111 only) | I_{OD} | — | 0.1 | — | μA | |

Note 1: Trip point is $\pm 1.5\%$ from typical value.

Note 2: Trip point is $\pm 2.5\%$ from typical value.

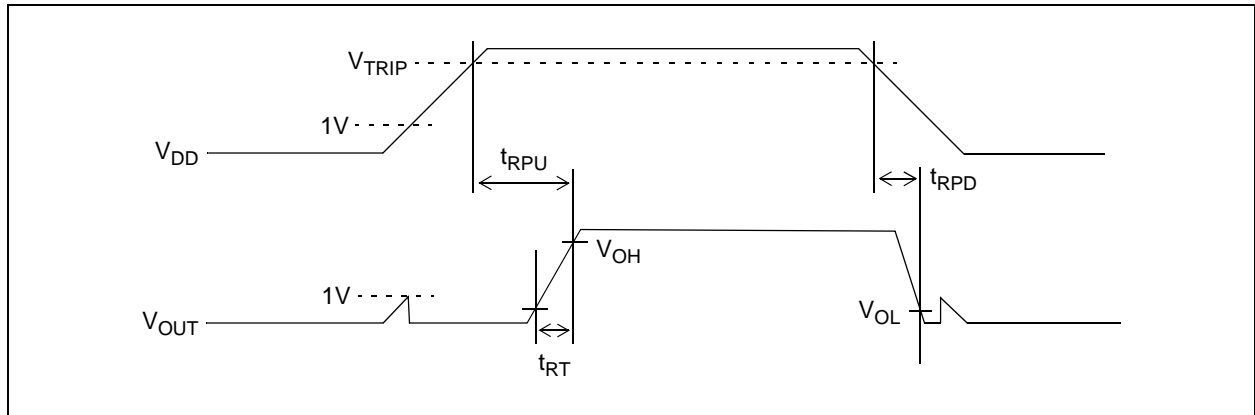

FIGURE 1-1: Timing Diagram.

AC CHARACTERISTICS

Electrical Specifications: Unless otherwise indicated, all limits are specified for $V_{DD} = 1V$ to $5.5V$, $R_{PU} = 100\text{ k}\Omega$ (only **MCP111**), $T_A = -40^\circ\text{C}$ to $+125^\circ\text{C}$.

| Parameters | Sym | Min | Typ | Max | Units | Conditions |
|--|-----------|-----|-----|-----|---------------|---|
| V_{DD} Detect to V_{OUT} Inactive | t_{RPU} | — | 90 | — | μs | Figure 1-1 and $C_L = 50\text{ pF}$ (Note 1) |
| V_{DD} Detect to V_{OUT} Active | t_{RPD} | — | 130 | — | μs | V_{DD} ramped from $V_{TRIP(MAX)} + 250\text{ mV}$ down to $V_{TRIP(MIN)} - 250\text{ mV}$, per Figure 1-1 , $C_L = 50\text{ pF}$ (Note 1) |
| V_{OUT} Rise Time After V_{OUT} Active | t_{RT} | — | 5 | — | μs | For V_{OUT} 10% to 90% of final value per Figure 1-1 , $C_L = 50\text{ pF}$ (Note 1) |

Note 1: These parameters are for design guidance only and are not 100% tested.

MCP111/112

TEMPERATURE CHARACTERISTICS

Electrical Specifications: Unless otherwise noted, all limits are specified for $V_{DD} = 1V$ to $5.5V$, $R_{PU} = 100\text{ k}\Omega$ (only **MCP111**), $T_A = -40^\circ\text{C}$ to $+125^\circ\text{C}$.

| Parameters | Sym | Min | Typ | Max | Units | Conditions |
|------------------------------------|---------------|-----|-------|------|--------------------|--------------------------|
| Temperature Ranges | | | | | | |
| Specified Temperature Range | T_A | -40 | — | +85 | $^\circ\text{C}$ | MCP1XX-195 |
| Specified Temperature Range | T_A | -40 | — | +125 | $^\circ\text{C}$ | Except MCP1XX-195 |
| Maximum Junction Temperature | T_J | — | — | +150 | $^\circ\text{C}$ | |
| Storage Temperature Range | T_A | -65 | — | +150 | $^\circ\text{C}$ | |
| Package Thermal Resistances | | | | | | |
| Thermal Resistance, 3L-SOT23 | θ_{JA} | — | 336 | — | $^\circ\text{C/W}$ | |
| Thermal Resistance, 3L-SC-70 | θ_{JA} | — | 340 | — | $^\circ\text{C/W}$ | |
| Thermal Resistance, 3L-TO92 | θ_{JA} | — | 131.9 | — | $^\circ\text{C/W}$ | |

2.0 TYPICAL PERFORMANCE CURVES

Note: The graphs and tables provided following this note are a statistical summary based on a limited number of samples and are provided for informational purposes only. The performance characteristics listed herein are not tested or guaranteed. In some graphs or tables, the data presented may be outside the specified operating range (e.g., outside specified power supply range) and therefore outside the warranted range.

Note: Unless otherwise indicated, all limits are specified for $V_{DD} = 1V$ to $5.5V$, $R_{PU} = 100\text{ k}\Omega$ (only **MCP111**; see **Figure 4-1**), $T_A = -40^\circ\text{C}$ to $+125^\circ\text{C}$.

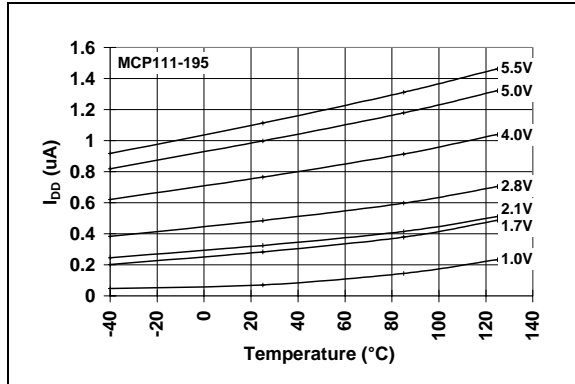

FIGURE 2-1: I_{DD} vs. Temperature (MCP111-195).

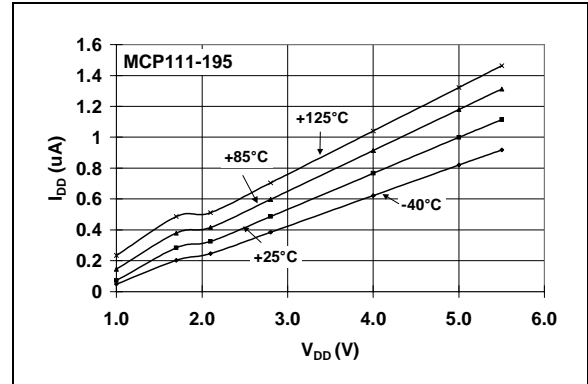

FIGURE 2-4: I_{DD} vs. V_{DD} (MCP111-195).

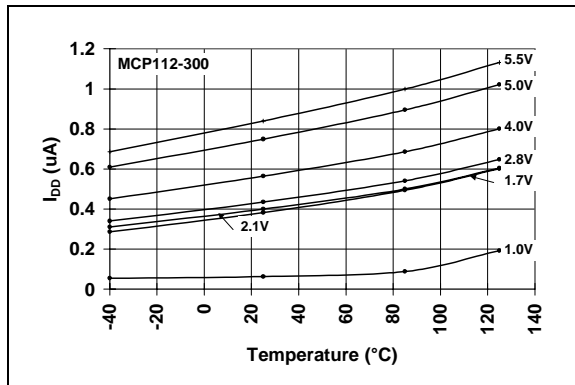

FIGURE 2-2: I_{DD} vs. Temperature (MCP112-300).

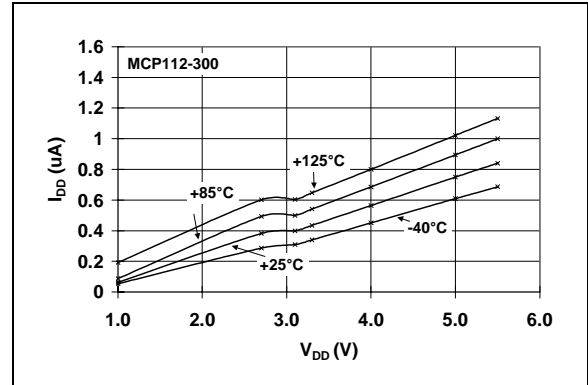

FIGURE 2-5: I_{DD} vs. V_{DD} (MCP112-300).

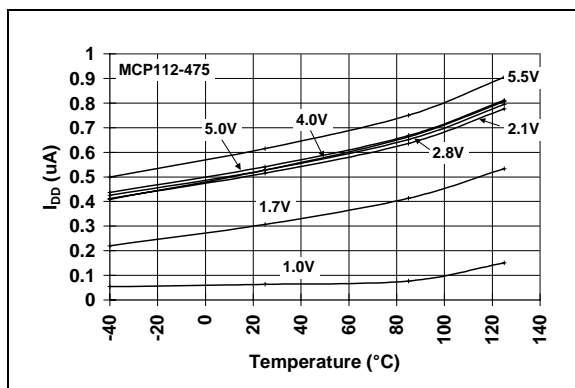

FIGURE 2-3: I_{DD} vs. Temperature (MCP112-475).

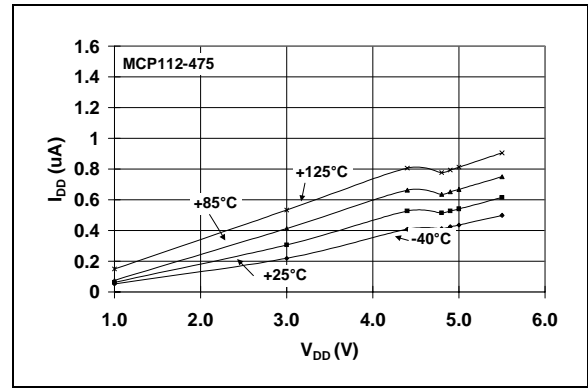

FIGURE 2-6: I_{DD} vs. V_{DD} (MCP112-475).

MCP111/112

Note: Unless otherwise indicated, all limits are specified for $V_{DD} = 1V$ to $5.5V$, $R_{PU} = 100\text{ k}\Omega$ (only **MCP111**; see **Figure 4-1**), $T_A = -40^\circ\text{C}$ to $+125^\circ\text{C}$.

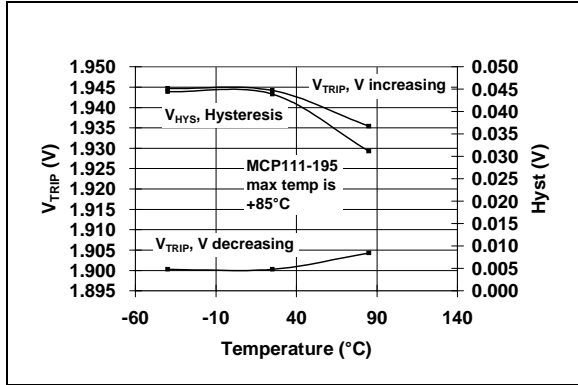

FIGURE 2-7: V_{TRIP} and V_{HYST} vs. Temperature (**MCP111-195**).

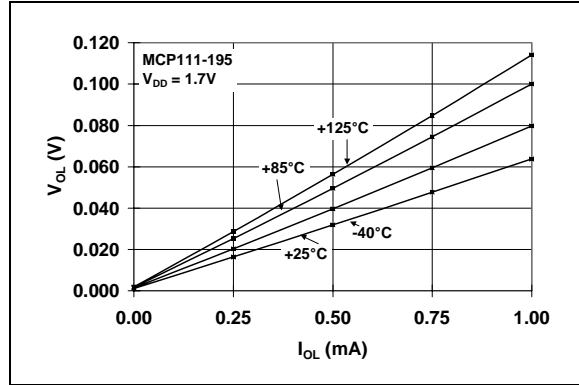

FIGURE 2-10: V_{OL} vs. I_{OL} (**MCP111-195** @ $V_{DD} = 1.7V$).

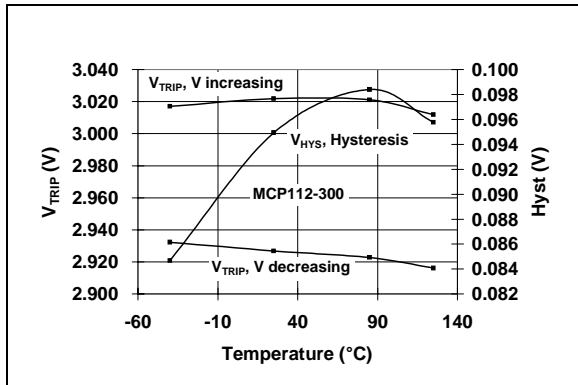

FIGURE 2-8: V_{TRIP} and V_{HYST} vs. Temperature (**MCP112-300**).

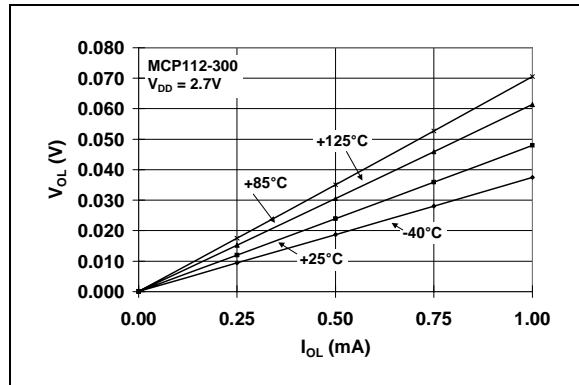

FIGURE 2-11: V_{OL} vs. I_{OL} (**MCP112-300** @ $V_{DD} = 2.7V$).

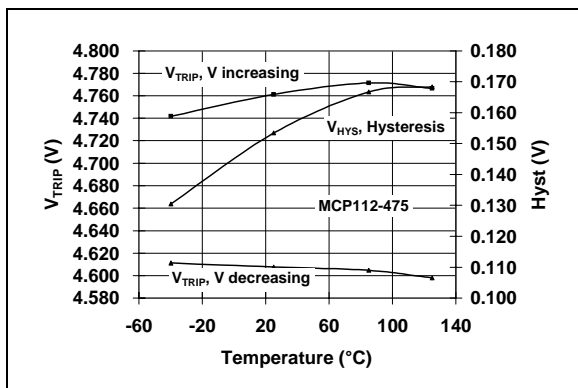

FIGURE 2-9: V_{TRIP} and V_{HYST} vs. Temperature (**MCP112-475**).

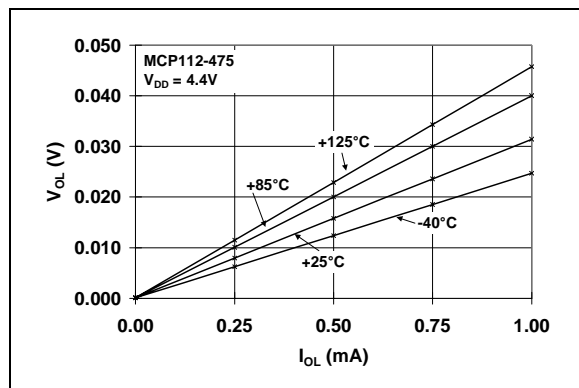

FIGURE 2-12: V_{OL} vs. I_{OL} (**MCP112-475** @ $V_{DD} = 4.4V$).

Note: Unless otherwise indicated, all limits are specified for $V_{DD} = 1V$ to $5.5V$, $R_{PU} = 100\text{ k}\Omega$ (only MCP111; see Figure 4-1), $T_A = -40^\circ\text{C}$ to $+125^\circ\text{C}$.

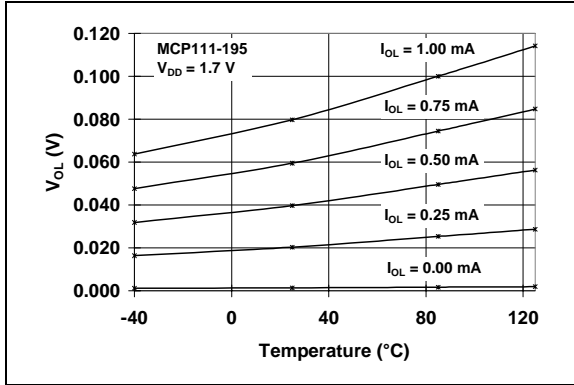

FIGURE 2-13: V_{OL} vs. Temperature (MCP111-195 @ $V_{DD} = 1.7V$).

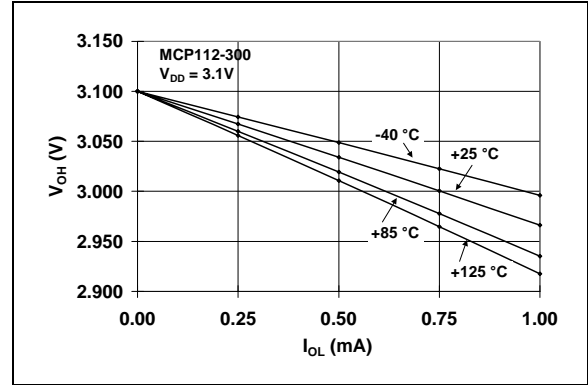

FIGURE 2-16: V_{OH} vs. I_{OH} (MCP112-300 @ $V_{DD} = 3.1V$).

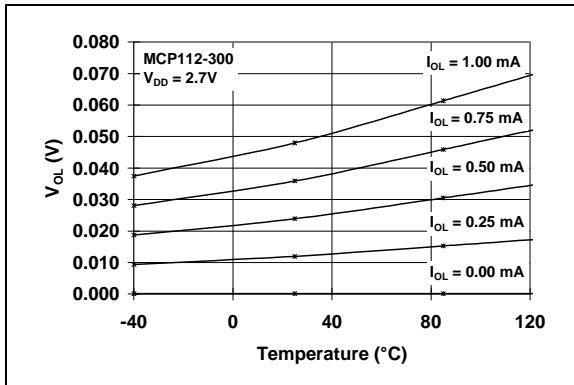

FIGURE 2-14: V_{OL} vs. Temperature (MCP112-300 @ $V_{DD} = 2.7V$).

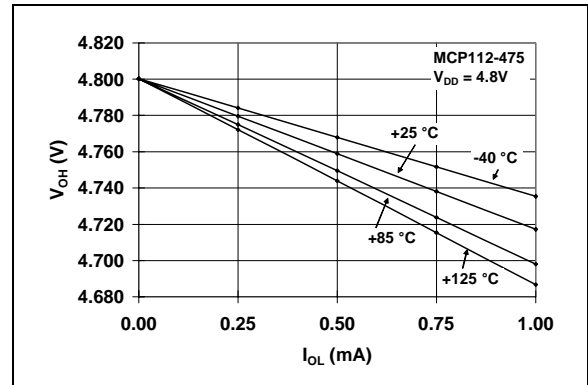

FIGURE 2-17: V_{OH} vs. I_{OH} (MCP112-475 @ $V_{DD} = 4.8V$).

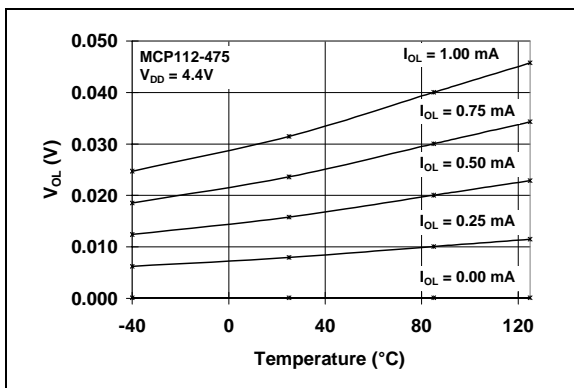

FIGURE 2-15: V_{OL} vs. Temperature (MCP112-475 @ $V_{DD} = 4.4V$).

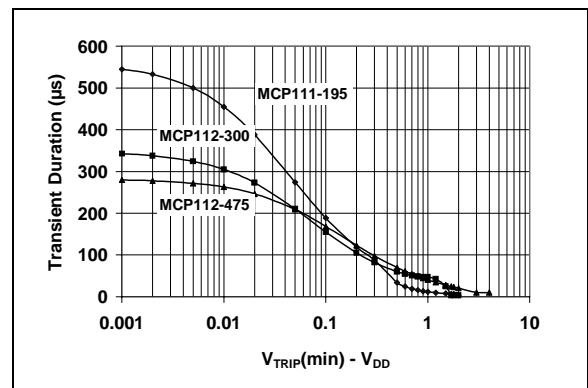

FIGURE 2-18: Typical Transient Response (25°C).

MCP111/112

Note: Unless otherwise indicated, all limits are specified for $V_{DD} = 1V$ to $5.5V$, $R_{PU} = 100\text{ k}\Omega$ (only MCP111; see Figure 4-1), $T_A = -40^\circ\text{C}$ to $+125^\circ\text{C}$.

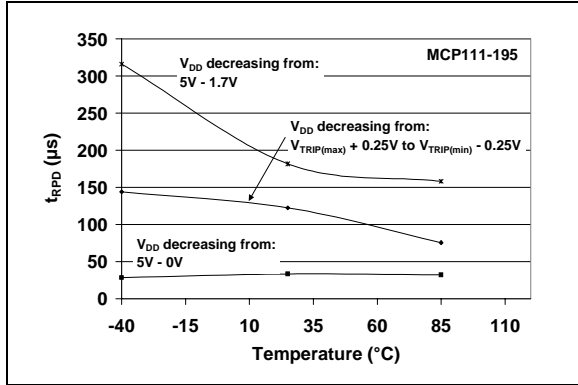

FIGURE 2-19: t_{RPD} vs. Temperature (MCP111-195).

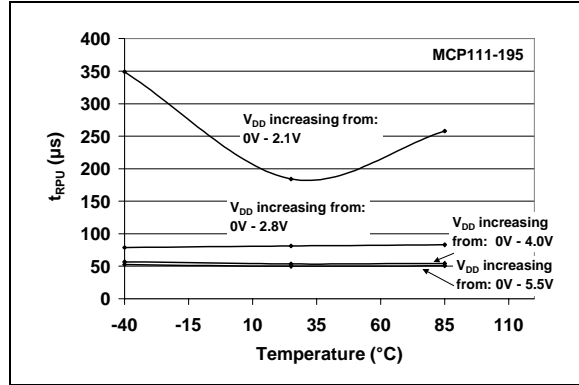

FIGURE 2-22: t_{RPU} vs. Temperature (MCP111-195).

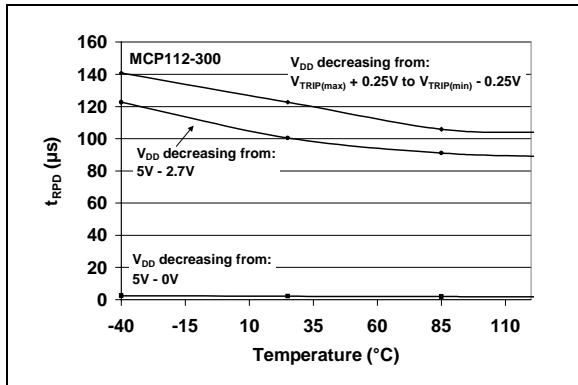

FIGURE 2-20: t_{RPD} vs. Temperature (MCP112-300).

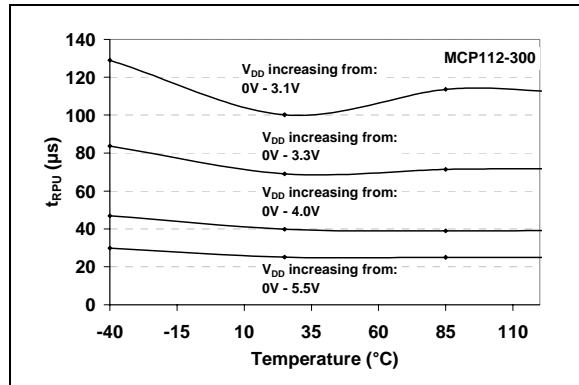

FIGURE 2-23: t_{RPU} vs. Temperature (MCP112-300).

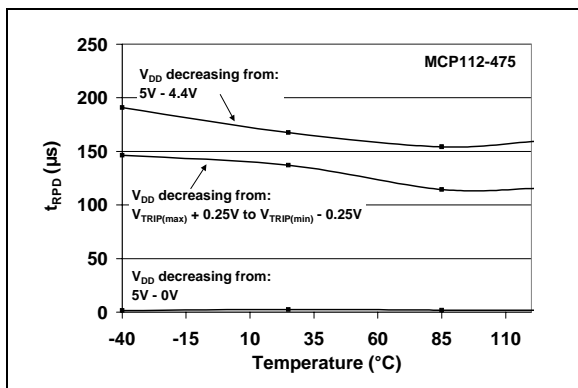

FIGURE 2-21: t_{RPD} vs. Temperature (MCP112-475).

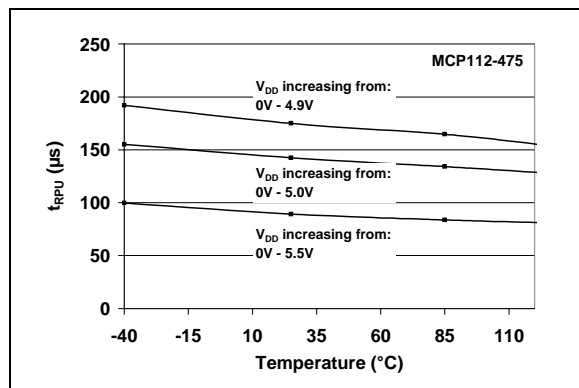

FIGURE 2-24: t_{RPU} vs. Temperature (MCP112-475).

Note: Unless otherwise indicated, all limits are specified for $V_{DD} = 1V$ to $5.5V$, $R_{PU} = 100\text{ k}\Omega$ (only MCP111; see Figure 4-1), $T_A = -40^\circ\text{C}$ to $+125^\circ\text{C}$.

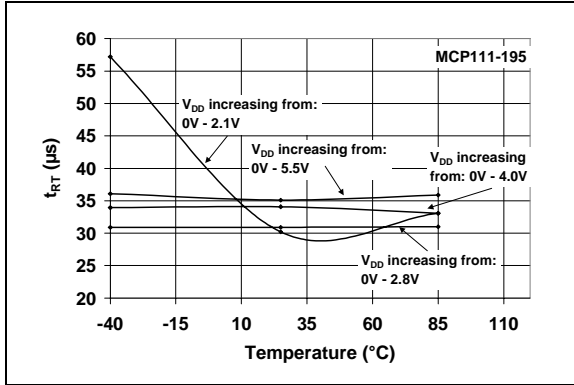

FIGURE 2-25: t_{RT} vs. Temperature (MCP111-195).

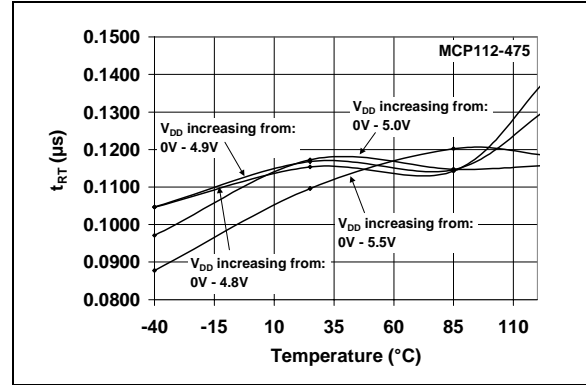

FIGURE 2-27: t_{RT} vs. Temperature (MCP112-475).

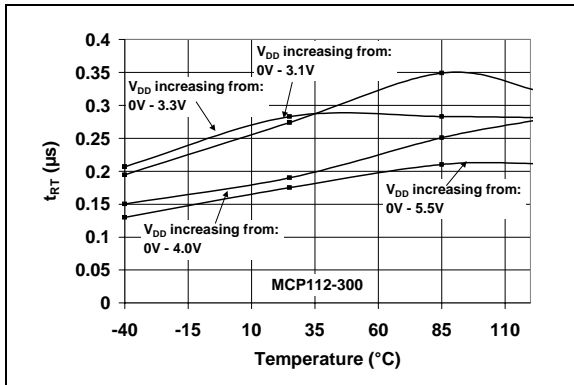

FIGURE 2-26: t_{RT} vs. Temperature (MCP112-300).

MCP111/112

3.0 PIN DESCRIPTION

The descriptions of the pins are listed in Table 3-1.

TABLE 3-1: PIN FUNCTION TABLE

| Pin No. | | Symbol | Function |
|------------------|-------|-----------|--|
| SOT23-3 SC-70 | T0-92 | | |
| 1 | 1 | V_{OUT} | Output State V_{DD} Falling: $H = V_{DD} > V_{TRIP}$ $L = V_{DD} < V_{TRIP}$ V_{DD} Rising: $H = V_{DD} > V_{TRIP} + V_{HYS}$ $L = V_{DD} < V_{TRIP} + V_{HYS}$ |
| 2 | 3 | V_{SS} | Ground reference |
| 3 | 2 | V_{DD} | Positive power supply |

4.0 APPLICATION INFORMATION

For many of today's microcontroller applications, care must be taken to prevent low-power conditions that can cause many different system problems. The most common causes are brown-out conditions, where the system supply drops below the operating level momentarily. The second most common cause is when a slowly decaying power supply causes the microcontroller to begin executing instructions without sufficient voltage to sustain SRAM, thus producing indeterminate results. Figure 4-1 shows a typical application circuit.

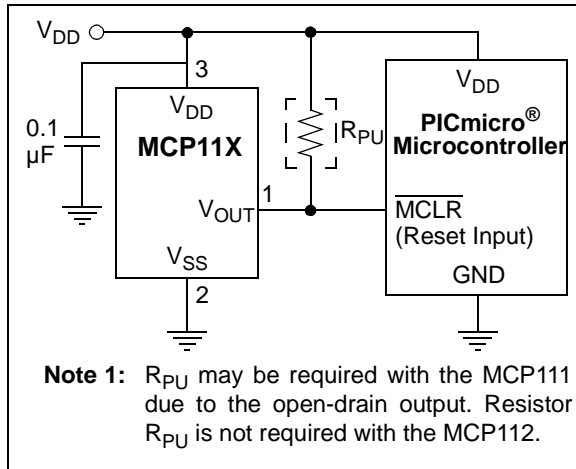

FIGURE 4-1: Typical Application Circuit.

4.1 V_{TRIP} Operation

The voltage trip point (V_{TRIP}) is determined on the falling edge of V_{DD} . The actual voltage trip point (V_{TRIPAC}) will be between the minimum trip point ($V_{TRIPMIN}$) and the maximum trip point ($V_{TRIPMAX}$). There is a hysteresis on this trip point to remove any "jitter" that would occur on the V_{OUT} pin when the device V_{DD} is at the trip point.

Figure 4-2 shows the state of the V_{OUT} pin as determined by the V_{DD} voltage. The V_{TRIP} specification is for falling V_{DD} voltages. When the V_{DD} voltage is rising, the V_{OUT} pin will not be driven high until V_{DD} is at $V_{TRIP} + V_{HYS}$.

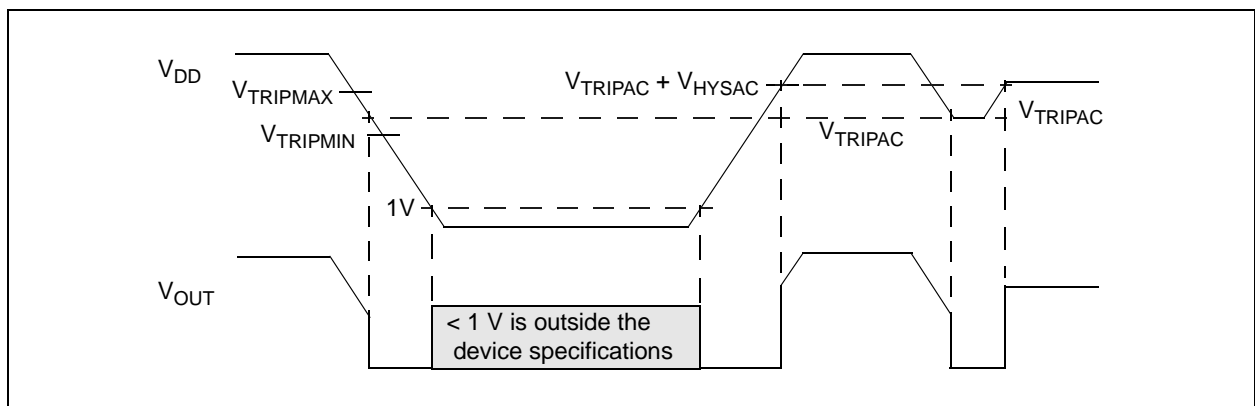

FIGURE 4-2: V_{OUT} Operation as Determined by the V_{TRIP} and V_{HYS} .

MCP111/112

4.2 Negative Going V_{DD} Transients

The minimum pulse width (time) required to cause a reset may be an important criteria in the implementation of a POR circuit. This time is referred to as transient duration and is the amount of time needed for these supervisory devices to respond to a drop in V_{DD} . The transient duration time is dependant on the magnitude of $V_{TRIP} - V_{DD}$. Generally speaking, the transient duration decreases with increases in $V_{TRIP} - V_{DD}$.

Figure 4-3 shows a typical transient duration vs. reset comparator overdrive for which the MCP111/112 will not generate a reset pulse. It shows that the farther below the trip point the transient pulse goes, the duration of the pulse required to cause a reset gets shorter. Figure 2-18 shows the transient response characteristics for the MCP111/112.

A 0.1 μ F bypass cap mounted as close as possible to the V_{DD} pin provides additional transient immunity (refer to Figure 4-1).

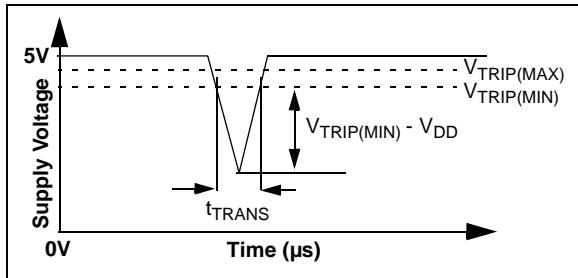

FIGURE 4-3: Example of Typical Transient Duration Waveform.

4.3 Effect of Temperature on Time-out Period (t_{RPU})

The time-out period (t_{RPU}) determines how long the device remains in the reset condition. This is affected by both V_{DD} and temperature. The graph shown in Figures 2-22, 2-23 and 2-24 show the typical response for different V_{DD} values and temperatures.

5.0 PACKAGING INFORMATION

5.1 Package Marking Information

3-Lead TO-92

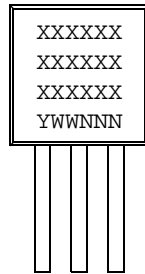

Example:

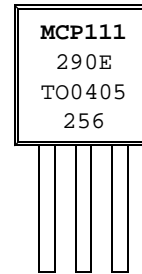

3-Pin SC-70

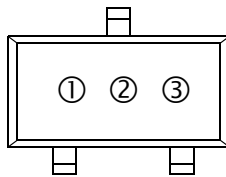

Top Side

Example:

| Part Number | SC-70 | Part Number | SC-70 |
|-----------------|-------|-----------------|-------|
| MCP111T-195/LB | EPN | MCP112T-195/LB | ERN |
| MCP111T-240E/LB | EQN | MCP112T-240E/LB | ESN |
| MCP111T-270E/LB | EGN | MCP112T-270E/LB | EAN |
| MCP111T-290E/LB | EHN | MCP112T-290E/LB | EBN |
| MCP111T-300E/LB | EJN | MCP112T-300E/LB | ECN |
| MCP111T-315E/LB | EKN | MCP112T-315E/LB | EDN |
| MCP111T-450E/LB | ELN | MCP112T-450E/LB | EEN |
| MCP111T-475E/LB | EMN | MCP112T-475E/LB | EFN |

3-Pin SOT-23B

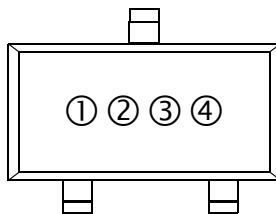

Example:

| Part Number | SOT-23 | Part Number | SOT-23 |
|-----------------|--------|-----------------|--------|
| MCP111T-195/TT | MPNN | MCP112T-195/TT | MRNN |
| MCP111T-240ETT | MQNN | MCP112T-240ETT | MSNN |
| MCP111T-270E/TT | MGNN | MCP112T-270E/TT | MANN |
| MCP111T-290E/TT | NHNN | MCP112T-290E/TT | MBNN |
| MCP111T-300E/TT | MJNN | MCP112T-300E/TT | MCNN |
| MCP111T-315E/TT | MKNN | MCP112T-315E/TT | MDNN |
| MCP111T-450E/TT | MLNN | MCP112T-450E/TT | MENN |
| MCP111T-475E/TT | MMNN | MCP112T-475E/TT | MFNN |

| | | |
|----------------|---|--|
| Legend: | 1 | Part Number + temperature range and voltage (two-digit code) |
| | 2 | Part Number + temperature range and voltage (two-digit code) |
| | 3 | Lot ID number |
| | 4 | Year and work week |

Note: In the event the full Microchip part number cannot be marked on one line, it will be carried over to the next line thus limiting the number of available characters for customer specific information.

MCP111/112

3-Lead Plastic Small Outline Transistor (TT) (SOT-23)

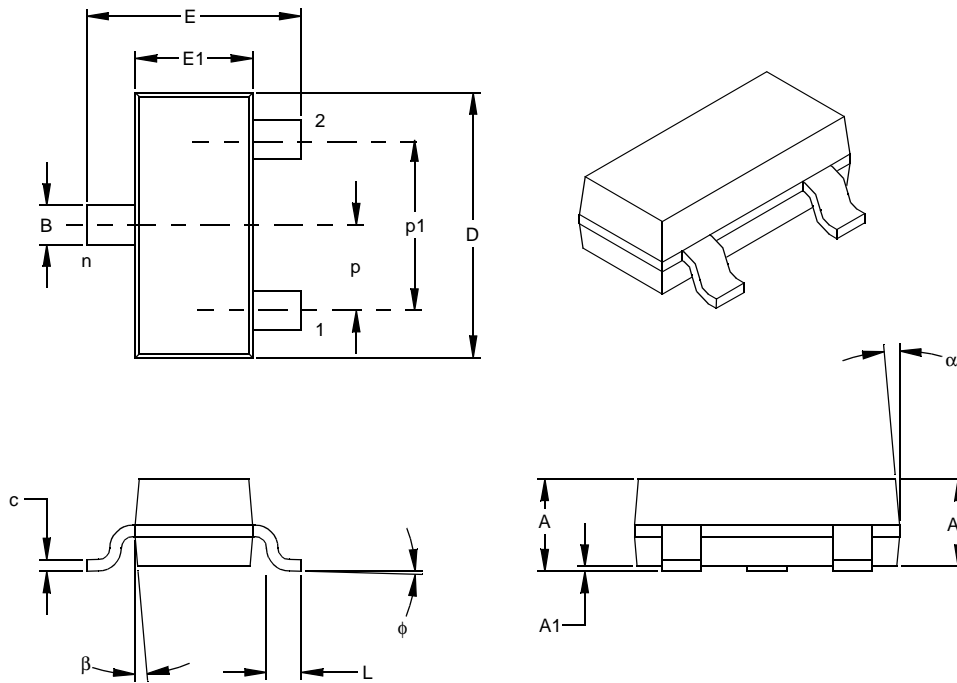

| Units | | INCHES* | | | MILLIMETERS | | |
|----------------------------|--------|---------|------|------|-------------|------|------|
| Dimension | Limits | MIN | NOM | MAX | MIN | NOM | MAX |
| Number of Pins | n | | 3 | | | 3 | |
| Pitch | p | | .038 | | | 0.96 | |
| Outside lead pitch (basic) | p1 | | .076 | | | 1.92 | |
| Overall Height | A | .035 | .040 | .044 | 0.89 | 1.01 | 1.12 |
| Molded Package Thickness | A2 | .035 | .037 | .040 | 0.88 | 0.95 | 1.02 |
| Standoff § | A1 | .000 | .002 | .004 | 0.01 | 0.06 | 0.10 |
| Overall Width | E | .083 | .093 | .104 | 2.10 | 2.37 | 2.64 |
| Molded Package Width | E1 | .047 | .051 | .055 | 1.20 | 1.30 | 1.40 |
| Overall Length | D | .110 | .115 | .120 | 2.80 | 2.92 | 3.04 |
| Foot Length | L | .014 | .018 | .022 | 0.35 | 0.45 | 0.55 |
| Foot Angle | φ | 0 | 5 | 10 | 0 | 5 | 10 |
| Lead Thickness | c | .004 | .006 | .007 | 0.09 | 0.14 | 0.18 |
| Lead Width | B | .015 | .017 | .020 | 0.37 | 0.44 | 0.51 |
| Mold Draft Angle Top | α | 0 | 5 | 10 | 0 | 5 | 10 |
| Mold Draft Angle Bottom | β | 0 | 5 | 10 | 0 | 5 | 10 |

* Controlling Parameter
 § Significant Characteristic

Notes:

Dimensions D and E1 do not include mold flash or protrusions. Mold flash or protrusions shall not exceed .010" (0.254mm) per side.

JEDEC Equivalent: TO-236

Drawing No. C04-104

3-Lead Plastic Small Outline Transistor (LB) (SC-70)

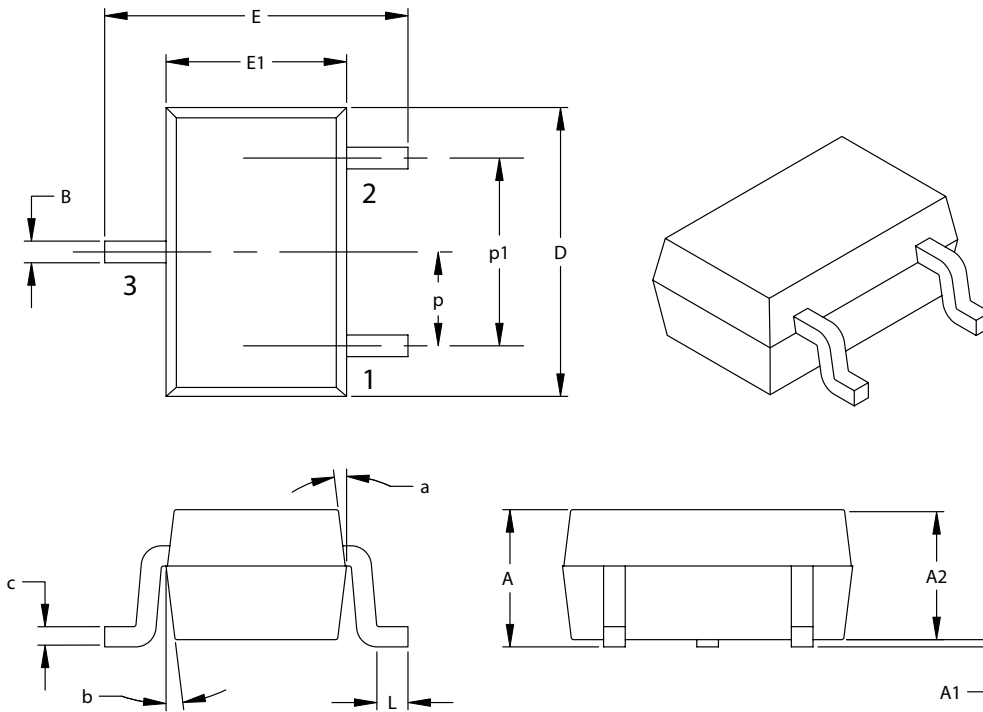

| Dimension Limits | Units | INCHES | | MILLIMETERS* | |
|----------------------------|-------|-----------|-------|--------------|------|
| | | MIN | MAX | MIN | MAX |
| Number of Pins | | 3 | | 3 | |
| Pitch | p | .026 BSC. | | 0.65 BSC. | |
| Outside lead pitch (basic) | p1 | .051 BSC. | | 1.30 BSC. | |
| Overall Height | A | .031 | .043 | 0.80 | 1.10 |
| Molded Package Thickness | A2 | .031 | .039 | 0.80 | 1.00 |
| Standoff | A1 | .000 | .0004 | 0.00 | .010 |
| Overall Width | E | .071 | .094 | 1.80 | 2.40 |
| Molded Package Width | E1 | .045 | .053 | 1.15 | 1.35 |
| Overall Length | D | .071 | .089 | 1.80 | 2.25 |
| Foot Length | L | .004 | .016 | 0.10 | 0.41 |
| Lead Thickness | c | .003 | .010 | 0.08 | 0.25 |
| Lead Width | B | .006 | .016 | 0.15 | 0.40 |
| Mold Draft Angle Top | a | 8° | 12° | 8° | 12° |
| Mold Draft Angle Bottom | b | 8° | 12° | 8° | 12° |

*Controlling Parameter

Notes:

Dimensions D and E1 do not include mold flash or protrusions. Mold flash or protrusions shall not exceed .005" (0.127mm) per side.

JEITA (EIAJ) Equivalent: SC70

Drawing No. C04-104

MCP111/112

3-Lead Plastic Transistor Outline (TO) (TO-92)

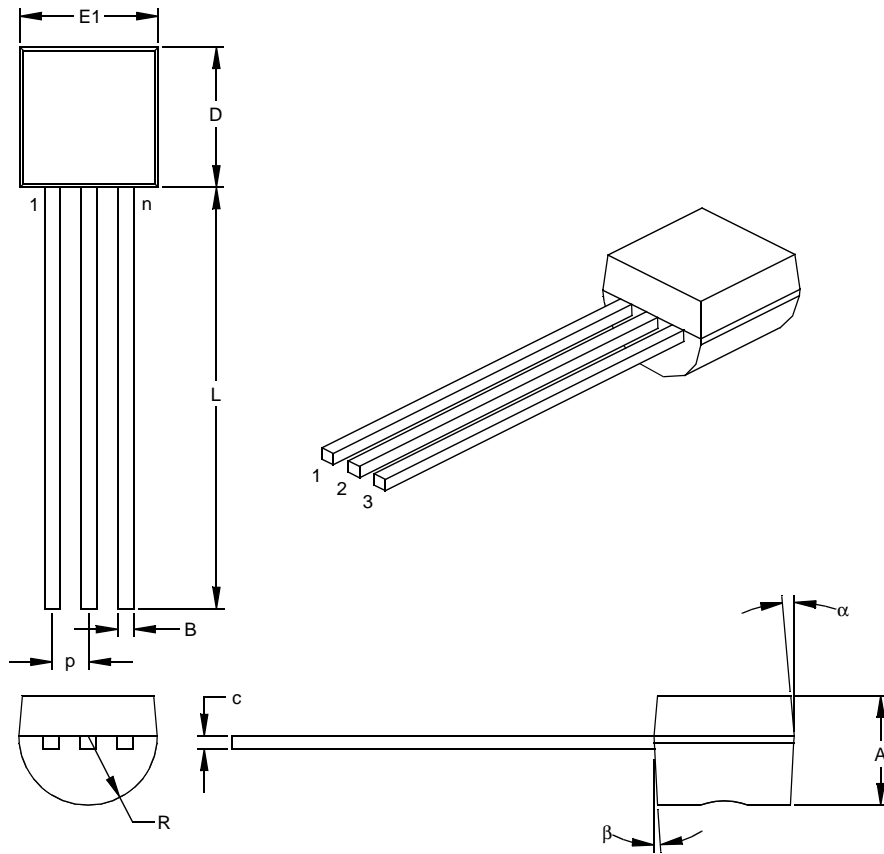

| Dimension Limits | Units | INCHES* | | | MILLIMETERS | | |
|-------------------------|----------|---------|------|------|-------------|-------|-------|
| | | MIN | NOM | MAX | MIN | NOM | MAX |
| Number of Pins | n | | 3 | | | 3 | |
| Pitch | p | | .050 | | | 1.27 | |
| Bottom to Package Flat | A | .130 | .143 | .155 | 3.30 | 3.62 | 3.94 |
| Overall Width | E1 | .175 | .186 | .195 | 4.45 | 4.71 | 4.95 |
| Overall Length | D | .170 | .183 | .195 | 4.32 | 4.64 | 4.95 |
| Molded Package Radius | R | .085 | .090 | .095 | 2.16 | 2.29 | 2.41 |
| Tip to Seating Plane | L | .500 | .555 | .610 | 12.70 | 14.10 | 15.49 |
| Lead Thickness | c | .014 | .017 | .020 | 0.36 | 0.43 | 0.51 |
| Lead Width | B | .016 | .019 | .022 | 0.41 | 0.48 | 0.56 |
| Mold Draft Angle Top | α | 4 | 5 | 6 | 4 | 5 | 6 |
| Mold Draft Angle Bottom | β | 2 | 3 | 4 | 2 | 3 | 4 |

*Controlling Parameter

Notes:

Dimensions D and E1 do not include mold flash or protrusions. Mold flash or protrusions shall not exceed .010" (0.254mm) per side.

JEDEC Equivalent: TO-92

Drawing No. C04-101

5.2 Product Tape and Reel Specifications

FIGURE 5-1: EMBOSED CARRIER DIMENSIONS (8, 12, 16 AND 24 MM TAPE ONLY)

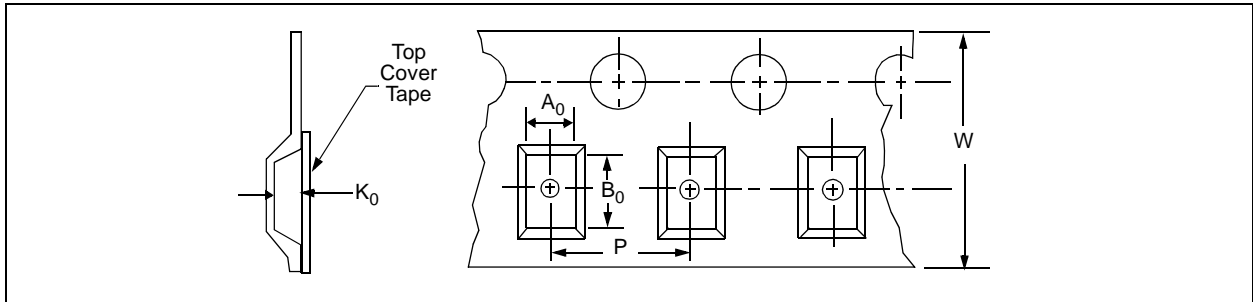
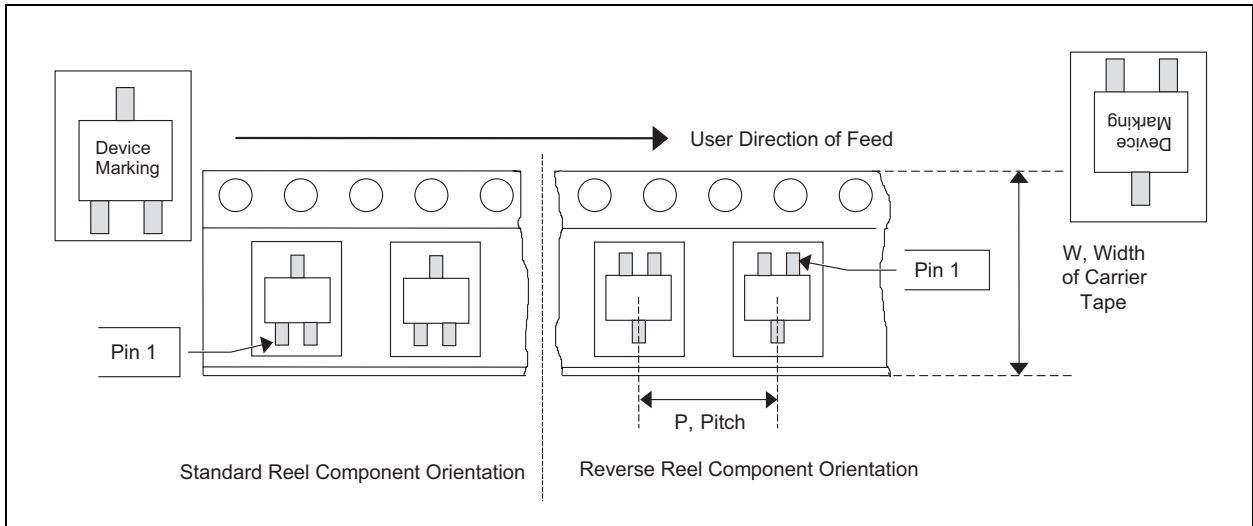

TABLE 1: CARRIER TAPE/CAVITY DIMENSIONS

| Case Outline | Package Type | | Carrier Dimensions | | Cavity Dimensions | | | Output Quantity Units | Reel Diameter in mm |
|--------------|--------------|----|--------------------|------|-------------------|-------|-------|-----------------------|---------------------|
| | | | W mm | P mm | A0 mm | B0 mm | K0 mm | | |
| TT | SOT-23B | 3L | 8 | 4 | 3.15 | 2.77 | 1.22 | 3000 | 180 |
| LB | SC-70 | 3L | 8 | 4 | 2.4 | 2.4 | 1.19 | 3000 | 180 |

FIGURE 5-2: 3-LEAD SOT-23/SC70 DEVICE TAPE AND REEL SPECIFICATIONS



MCP111/112

FIGURE 5-3: TO-92 DEVICES

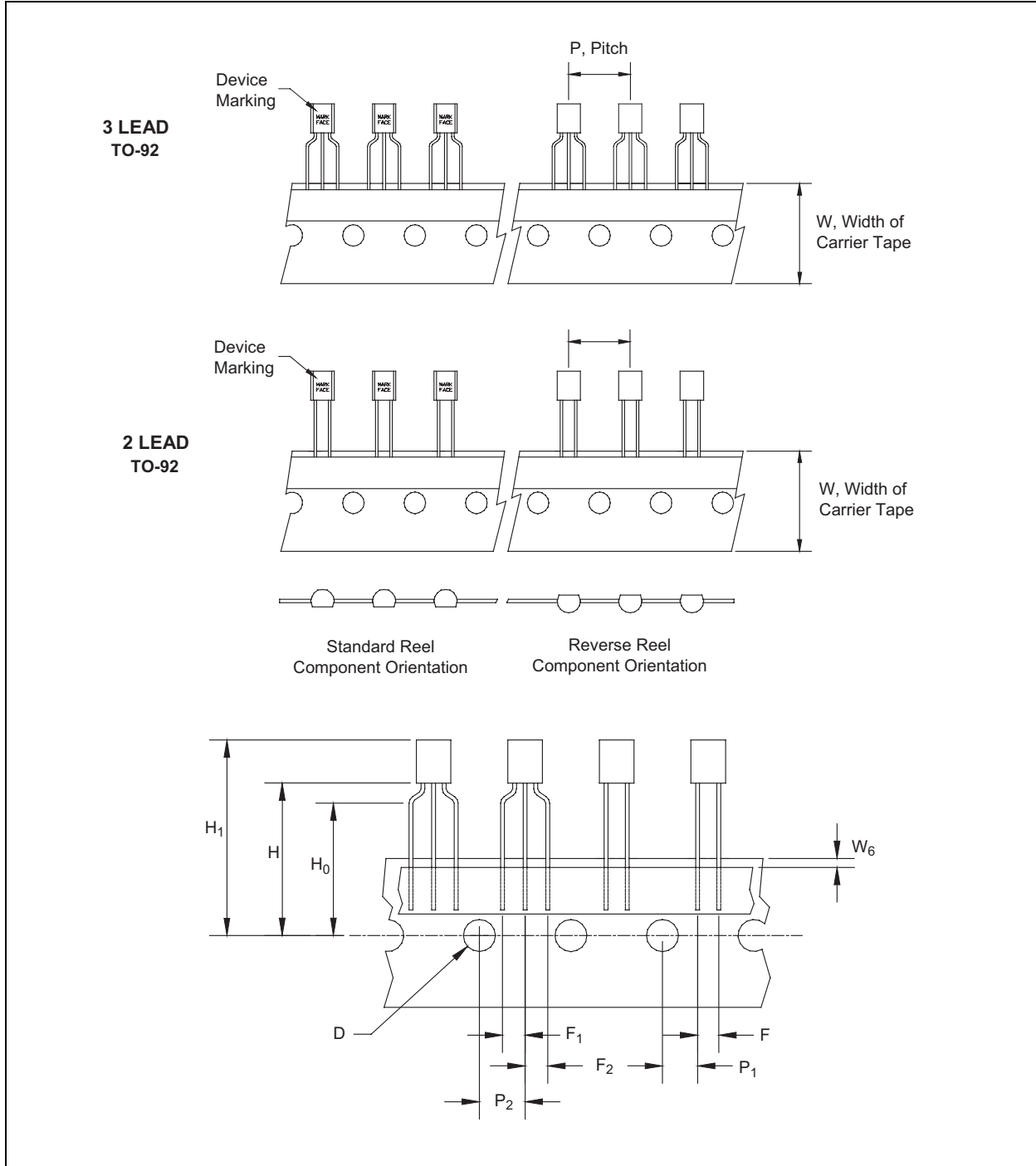

PRODUCT IDENTIFICATION SYSTEM

To order or obtain information, e.g., on pricing or delivery, refer to the factory or the listed sales office.

| <u>PART NO.</u> | <u>X</u> | <u>XXX</u> | <u>X</u> | <u>XX</u> | Examples: |
|---|---------------------|-----------------------|----------------------|-----------|---|
| Device | Tape/Reel Option | Monitoring Options | Temperature Range | Package | |
| <p>Device:</p> <p>MCP111: MicroPower Voltage Detector, open-drain MCP111T: MicroPower Voltage Detector, open-drain (Tape and Reel)</p> <p>MCP112: MicroPower Voltage Detector, push-pull MCP112T: MicroPower Voltage Detector, push-pull (Tape and Reel)</p> <p>Monitoring Options:</p> <p>195 = 1.90V 240 = 2.32V 270 = 2.63V 290 = 2.90V 300 = 2.93V 315 = 3.08V 450 = 4.38V 475 = 4.63V</p> <p>Temperature Range:</p> <p>I = -40°C to +85°C (MCP11X-195 only) E = -40°C to +125°C (Except MCP11X-195 only)</p> <p>Package:</p> <p>TT = SOT-23B, 3-lead LB = SC-70, 3-lead TO = TO-92, 3-lead</p> | | | | | <p>a) MCP111T-195I/TT: Tape and Reel, 1.95V option, open-drain, -40°C to +85°C, SOT-23B package.</p> <p>b) MCP111T-315E/LB: Tape and Reel, 3.15V option, open-drain, -40°C to +125°C, SC-70-3 package.</p> <p>c) MCP111-300E/TO: 3.00V option, open-drain, -40°C to +125°C, TO-92-3 package.</p> <p>a) MCP112T-290E/TT: Tape and Reel, 2.90V option, push-pull, - 40°C to +125°C, SOT-23B-3 package.</p> <p>b) MCP112T-475E/LB: Tape and Reel, 4.75V option, push-pull, -40°C to +125°C, SC-70-3 package.</p> <p>c) MCP112-450E/TO: 4.5V option, push-pull, -40°C to +125°C, TO-92-3 package.</p> |

Sales and Support

Data Sheets

Products supported by a preliminary Data Sheet may have an errata sheet describing minor operational differences and recommended workarounds. To determine if an errata sheet exists for a particular device, please contact one of the following:

1. Your local Microchip sales office
2. The Microchip Corporate Literature Center U.S. FAX: (480) 792-7277
3. The Microchip Worldwide Site (www.microchip.com)

Please specify which device, revision of silicon and Data Sheet (include Literature #) you are using.

Customer Notification System

Register on our web site (www.microchip.com/cn) to receive the most current information on our products.

MCP111/112

NOTES:

Note the following details of the code protection feature on Microchip devices:

- Microchip products meet the specification contained in their particular Microchip Data Sheet.
- Microchip believes that its family of products is one of the most secure families of its kind on the market today, when used in the intended manner and under normal conditions.
- There are dishonest and possibly illegal methods used to breach the code protection feature. All of these methods, to our knowledge, require using the Microchip products in a manner outside the operating specifications contained in Microchip's Data Sheets. Most likely, the person doing so is engaged in theft of intellectual property.
- Microchip is willing to work with the customer who is concerned about the integrity of their code.
- Neither Microchip nor any other semiconductor manufacturer can guarantee the security of their code. Code protection does not mean that we are guaranteeing the product as "unbreakable."

Code protection is constantly evolving. We at Microchip are committed to continuously improving the code protection features of our products. Attempts to break Microchip's code protection feature may be a violation of the Digital Millennium Copyright Act. If such acts allow unauthorized access to your software or other copyrighted work, you may have a right to sue for relief under that Act.

Information contained in this publication regarding device applications and the like is intended through suggestion only and may be superseded by updates. It is your responsibility to ensure that your application meets with your specifications. No representation or warranty is given and no liability is assumed by Microchip Technology Incorporated with respect to the accuracy or use of such information, or infringement of patents or other intellectual property rights arising from such use or otherwise. Use of Microchip's products as critical components in life support systems is not authorized except with express written approval by Microchip. No licenses are conveyed, implicitly or otherwise, under any intellectual property rights.

Trademarks

The Microchip name and logo, the Microchip logo, Accuron, dsPIC, KEELOQ, microID, MPLAB, PIC, PICmicro, PICSTART, PRO MATE, PowerSmart, rfPIC, and SmartShunt are registered trademarks of Microchip Technology Incorporated in the U.S.A. and other countries.

AmpLab, FilterLab, MXDEV, MXLAB, PICMASTER, SEEVAL, SmartSensor and The Embedded Control Solutions Company are registered trademarks of Microchip Technology Incorporated in the U.S.A.

Analog-for-the-Digital Age, Application Maestro, dsPICDEM, dsPICDEM.net, dsPICworks, ECAN, ECONOMONITOR, FanSense, FlexROM, fuzzyLAB, In-Circuit Serial Programming, ICSP, ICEPIC, Migratable Memory, MPASM, MPLIB, MPLINK, MPSIM, PICkit, PICDEM, PICDEM.net, PICLAB, PICtail, PowerCal, PowerInfo, PowerMate, PowerTool, rLAB, rfPICDEM, Select Mode, Smart Serial, SmartTel and Total Endurance are trademarks of Microchip Technology Incorporated in the U.S.A. and other countries.

SQTP is a service mark of Microchip Technology Incorporated in the U.S.A.

All other trademarks mentioned herein are property of their respective companies.

© 2004, Microchip Technology Incorporated, Printed in the U.S.A., All Rights Reserved.

 Printed on recycled paper.

**QUALITY MANAGEMENT SYSTEM
CERTIFIED BY DNV
== ISO/TS 16949:2002 ==**

Microchip received ISO/TS-16949:2002 quality system certification for its worldwide headquarters, design and wafer fabrication facilities in Chandler and Tempe, Arizona and Mountain View, California in October 2003. The Company's quality system processes and procedures are for its PICmicro® 8-bit MCUs, KEELOQ® code hopping devices, Serial EEPROMs, microperipherals, nonvolatile memory and analog products. In addition, Microchip's quality system for the design and manufacture of development systems is ISO 9001:2000 certified.



WORLDWIDE SALES AND SERVICE

AMERICAS

Corporate Office
2355 West Chandler Blvd.
Chandler, AZ 85224-6199
Tel: 480-792-7200
Fax: 480-792-7277
Technical Support:
480-792-7627
Web Address:
www.microchip.com

Atlanta

Alpharetta, GA
Tel: 770-640-0034
Fax: 770-640-0307

Boston

Westford, MA
Tel: 978-692-3848
Fax: 978-692-3821

Chicago

Itasca, IL
Tel: 630-285-0071
Fax: 630-285-0075

Dallas

Addison, TX
Tel: 972-818-7423
Fax: 972-818-2924

Detroit

Farmington Hills, MI
Tel: 248-538-2250
Fax: 248-538-2260

Kokomo

Kokomo, IN
Tel: 765-864-8360
Fax: 765-864-8387

Los Angeles

Mission Viejo, CA
Tel: 949-462-9523
Fax: 949-462-9608

San Jose

Mountain View, CA
Tel: 650-215-1444
Fax: 650-961-0286

Toronto

Mississauga, Ontario,
Canada
Tel: 905-673-0699
Fax: 905-673-6509

ASIA/PACIFIC

Australia - Sydney
Tel: 61-2-9868-6733
Fax: 61-2-9868-6755

China - Beijing
Tel: 86-10-8528-2100
Fax: 86-10-8528-2104

China - Chengdu
Tel: 86-28-8676-6200
Fax: 86-28-8676-6599

China - Fuzhou
Tel: 86-591-750-3506
Fax: 86-591-750-3521

China - Hong Kong SAR
Tel: 852-2401-1200
Fax: 852-2401-3431

China - Shanghai
Tel: 86-21-6275-5700
Fax: 86-21-6275-5060

China - Shenzhen
Tel: 86-755-8290-1380
Fax: 86-755-8295-1393

China - Shunde
Tel: 86-757-2839-5507
Fax: 86-757-2839-5571

China - Qingdao
Tel: 86-532-502-7355
Fax: 86-532-502-7205

ASIA/PACIFIC

India - Bangalore
Tel: 91-80-2229-0061
Fax: 91-80-2229-0062

India - New Delhi
Tel: 91-11-5160-8632
Fax: 91-11-5160-8632

Japan - Kanagawa
Tel: 81-45-471- 6166
Fax: 81-45-471-6122

Korea - Seoul
Tel: 82-2-554-7200
Fax: 82-2-558-5932 or
82-2-558-5934

Singapore
Tel: 65-6334-8870
Fax: 65-6334-8850

Taiwan - Kaohsiung
Tel: 886-7-536-4816
Fax: 886-7-536-4817

Taiwan - Taipei
Tel: 886-2-2500-6610
Fax: 886-2-2508-0102

Taiwan - Hsinchu
Tel: 886-3-572-9526
Fax: 886-3-572-6459

EUROPE

Austria - Weis
Tel: 43-7242-2244-399
Fax: 43-7242-2244-393

Denmark - Ballerup
Tel: 45-4420-9895
Fax: 45-4420-9910

France - Massy
Tel: 33-1-69-53-63-20
Fax: 33-1-69-30-90-79

Germany - Ismaning
Tel: 49-89-627-144-0
Fax: 49-89-627-144-44

Italy - Milan
Tel: 39-0331-742611
Fax: 39-0331-466781

Netherlands - Drunen
Tel: 31-416-690399
Fax: 31-416-690340

England - Berkshire
Tel: 44-118-921-5869
Fax: 44-118-921-5820

08/24/04